

## FCF-HD

The Floor to Ceiling Mount frame is designed to accommodate WS series racks in situations where there is no secure wall to fix to. This frame allows fixing instead to floor and ceiling and can be cut to suit any height up to 3m. Any suitable combination of WS racks can then be mounted front and/or back of the frame depending on individual requirements.

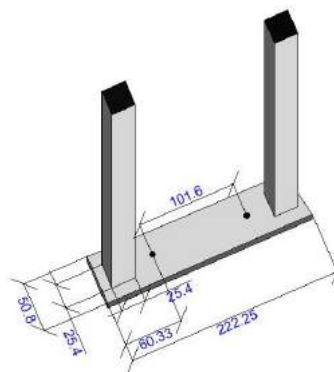
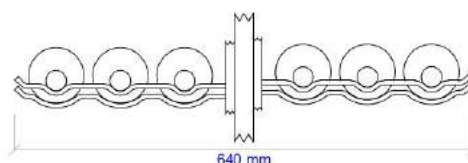
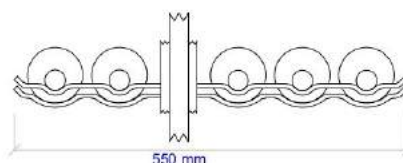
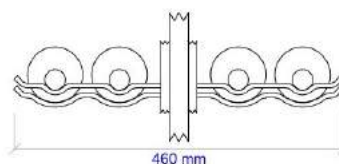
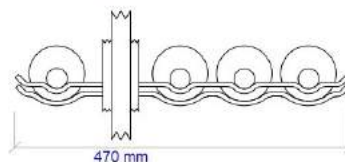
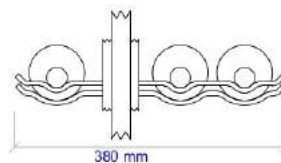
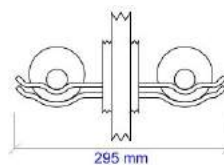
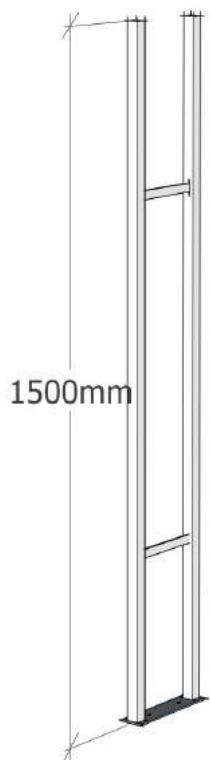
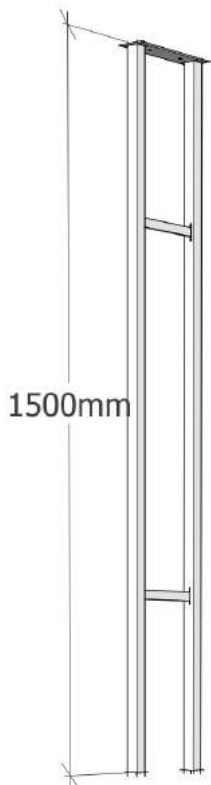

SPECIALISTS